

# EFRC Guidelines



---

## **Guidelines for Vibrations in Reciprocating Compressor Systems**

---

---

© European Forum Reciprocating Compressors (EFRC), 2009  
Third Edition  
May 2012

<b>1</b>	<b>Scope.....</b>	<b>3</b>
	<b>Definitions .....</b>	<b>4</b>
<b>2</b>	<b>Measurements.....</b>	<b>7</b>
2.1	<i>Measurements procedure.....</i>	7
2.1.1	<b>Measuring instrument and measured quantities .....</b>	<b>7</b>
2.2	<i>Points and direction of measurements.....</i>	8
2.3	<i>Operating conditions .....</i>	10
2.4	<i>Record of measured results.....</i>	10
<b>3</b>	<b>Vibration Criteria .....</b>	<b>11</b>
3.1	<i>Measuring quantities .....</i>	11
3.2	<i>Key zones .....</i>	11
3.3	<i>Guide values for acceptable overall vibrations (displacement, velocity and acceleration).....</i>	11
	<b>Annex A: Measuring procedure and data processing .....</b>	<b>17</b>
A 1.	<i>Compressor details:.....</i>	17
A 2.	<i>Measurements .....</i>	17
	<b>Annex B: Accelerometers.....</b>	<b>18</b>
B 1	<i>General .....</i>	18
B 2	<i>Mounting.....</i>	18
B 3.	<i>Cables .....</i>	20
	<b>Annex C: Post processing .....</b>	<b>21</b>
C 1.	<i>General.....</i>	21
C 2.	<i>Digital signal processing (DSP).....</i>	22
C.2.1	<i>General .....</i>	22
C 2.1	<i>Averaging .....</i>	23
C 2.2	<i>Filtering .....</i>	24
C 2.3	<i>Formation of the characteristic quantities .....</i>	25
C 2.4	<i>Signal display .....</i>	25
C 2.5	<i>Displaying in the time range.....</i>	25
C 2.6	<i>Displaying in the frequency range.....</i>	26
C 2.6.1	<i>Frequency analysis, frequency diagram.....</i>	26

## Foreword

The EFRC is the European Forum for Reciprocating Compressors and has been founded in 1999 by Neuman & Esser, Leobersdorfer Maschinenfabrik, Hoerbiger Ventilwerke, TNO Science & Industry, TU Dresden, Thomassen Compression Systems, Wärtsila Compression Systems and Burckhardt Compression. The target of the EFRC is to serve as a platform to facilitate exchange of information between vendors, operators and scientists working in the field of reciprocating compressors. This is achieved by knowledge transfer (conferences, internet, student workshops, training and seminars), standardization work (e.g. API 618, ISO 13707, and ISO 10816) and by joint pre-competitive research projects, aiming at improving the performance and the image of the reciprocating compressor.

In the R&D projects the forces are combined of all interested parties to solve or investigate problems which are beyond the scope of a single player. The basic research and pre-competitive research projects are carried out at research institutes or universities. In this way the R&D group of the EFRC will serve as the scientific arm of the reciprocating compressor community. The R&D group is open to all EFRC members and the annual budget is funded by participating members. The results are owned by the EFRC and the research results are disclosed to EFRC research group members only.

Vibrations are an important criterion to judge the safety, integrity and efficiency of compressor installations. For that purpose several international standards have been developed. The existing standards are considered to be unspecific and do not make a distinction in vibration levels for different parts of the reciprocating compressor system, e.g. foundation, frame, cylinder, pulsation dampers and piping. For that reason the “EFRC Guidelines for Vibrations in Reciprocating Compressor Systems” were developed.

The vibration levels from the guidelines are intended to be used during a field survey to judge the long term safety, reliability and efficiency. The guidelines are not intended for condition monitoring purposes.

Annex A, B and C form an integral part of this document. Annex A provides the minimum requirements for information related to the measurements that should be recorded, Appendix B provides an explanation on accelerometers and Appendix C provides guidance on post processing.

© European Forum Reciprocating Compressors (EFRC) 2009

All rights reserved. Unless otherwise specified, no part of this publication may be reproduced or utilized in any form or by any means, electronic or mechanical, including photocopying and microfilm, without permission in writing form of the publisher.

EFRC address:

EFRC

c/o Technische Universität Dresden

01062 Dresden

# 1 Scope

This EFRC Guideline is a document which establishes procedures and guidelines for the measurement and classification of mechanical vibration of reciprocating compressor systems

In general, the EFRC Guidelines are an extension of the ISO 10816-6 because this part of the ISO 10816 only refers to vibration of the main structure of the compressor,

The vibration levels from the EFRC Guidelines are defined primarily to classify the vibration of the compressor system and to avoid fatigue problems with parts in the reciprocating compressor system e.g. foundation, crankcase, cylinder, dampers, piping and auxiliary equipment mounted on the compressor system. The EFRC Guidelines are not intended for condition monitoring purposes.

Typical features of reciprocating compressors are the oscillating masses, the cyclically varying input torques and the pulsation-induced shaking forces in the associated compressor cylinder, pulsation dampers and pipe work.

Without limitation all these features can cause considerable vibration and cyclic stress levels in different parts of the system. The vibration levels of reciprocating compressors are generally higher than for rotating compressors but, since they are largely determined by the design features of the compressor they tend to remain more constant over the life of the compressors than for rotating compressors.

In the case of reciprocating compressors, the vibrations measured on the main parts of the compressor and quantified according to these guidelines may only give a rough indication of the stress levels and vibratory states of the components within the compressor itself. For example, torsional vibrations of rotating parts cannot generally be determined by measurements on the structural parts of the compressor.

The damage, which can occur when exceeding the guide values for acceptable vibrations, which are based on experience with similar compressor systems, is sustained predominantly by compressor-mounted components (e.g. instrumentation, heat-exchangers, filters, pumps), connecting elements of the compressor with its peripheral parts (e.g. pipelines, pulsation dampers) or monitoring instruments (e.g. pressure gauges, thermometers). The question as from which vibration values damage is to be expected largely depends on the design of these components and their fastenings. In some cases, special measurements on certain compressor system components will be required to ascertain that the vibration values are permissible. It also happens that even if measured values are within acceptable guide values, problems may occur owing to the great variety of components which can be attached. Such problems can be, and have to be, rectified by specific "local measures" (e.g. by elimination of resonances). Experience has shown, however, that it is possible in the majority of cases to state measurable quantities characterizing the vibratory state and to give guide values for these. This shows that the measurable variables and the guide values for acceptable vibrations in most cases permit a reliable evaluation. The vibrations of reciprocating compressor systems are not only affected by the properties of the compressor itself but also to a large degree by the foundation. Since a reciprocating compressor can act as a vibration generator, vibration isolation between the compressor and its foundation may be necessary in special cases.

This, as well as the vibration response of the foundation, can have considerable effect on the vibration of the compressor, pulsation dampers and attached piping itself. These vibration conditions are also dependent on the transmissibility of the environment surrounding the compressor and are therefore not entirely determined by the vibration values of the compressor itself. This guideline can therefore only take an advisory role in relation to the effects of the compressor on the environment.

# Definitions

For the purposes of this guideline, the following definitions given in ISO 10816-6, which are retrieved from ISO 2041, apply:

## **Acceleration**

Rate of change of velocity

In general, velocity is time-dependent.

The reference frame is usually a set of axes at a mean position or a position in rest. In general, a rotation acceleration vector, a translation acceleration vector, or both can represent the acceleration.

## **Accelerometer**

Transducer that converts an input acceleration to an output (usually electrical) that is proportional to the input acceleration

## **Aliasing error**

False representation of spectral energy caused by mixing of spectral components above the Nyquist frequency with those spectral components below the Nyquist frequency

## **Amplitude**

Magnitude, size or value of a quantity

## **Crest factor (CF)**

Ratio between peak and RMS value

## **Displacement**

Time varying quantity that specifies the change in position of a point on a body with respect to a reference frame.

The reference frame is usually a set of axes at a mean position or a position in rest. In general, a rotation displacement vector, a translation displacement vector, or both can represent the displacement.

## **Dominant frequency**

Frequency at which a maximum value occurs in a spectrum

## **Foundation**

Structure that supports a mechanical system

## **Fundamental period**

Smallest increment of time for which a periodic function repeats

## **Frequency**

Reciprocal value of the period

The unit of frequency is hertz (Hz) which corresponds to one cycle per second

## **Number of lines**

Number of spectral lines that are represented

## **Nyquist frequency**

Maximum usable frequency available in data taken at a given sampling rate

The Nyquist frequency is:  $f_N = f_s / 2$ , where  $f_s$  is sampling frequency

### Periodic vibration

Vibrations where the values of the vibration parameter recur for certain equal increments of the independent time variable.

The vibrations as referenced in this guideline are considered to be periodic.

### Record length

Number of data points comprising a contiguous set of sampled data points

### RMS

From the measured vibration velocity time signal, the RMS value may be calculated as follows:

$$v_{RMS} = \sqrt{\frac{1}{T} \int_0^T v^2(t) dt} \quad (1)$$

In which:

- $v(t)$  time dependent vibration velocity value
- $T$  sampling time

If the peak-to-peak displacement values of the vibration  $s_1, s_2, \dots, s_n$  in micrometers, or the RMS velocity values  $v_1, v_2, \dots, v_n$ , in millimetres per second, or the RMS acceleration values  $a_1, a_2, \dots, a_n$ , in meters per square second, and the frequencies  $f_1, f_2, \dots, f_n$ , in Hz are known, the associated RMS velocity in mm/s is given by:

$$v_{RMS} = \pi \times 10^{-3} \sqrt{\frac{1}{2} [(s_1 \cdot f_1)^2 + (s_2 \cdot f_2)^2 + \dots + (s_n \cdot f_n)^2]} \quad (2)$$

$$v_{RMS} = \sqrt{v_1^2 + v_2^2 + \dots + v_n^2} \quad (3)$$

$$v_{RMS} = \frac{10^3}{2\pi} \sqrt{\left[ \left( \frac{a_1}{f_1} \right)^2 + \left( \frac{a_2}{f_2} \right)^2 + \dots + \left( \frac{a_n}{f_n} \right)^2 \right]} \quad (4)$$

### RMS spectrum

Amplitude spectrum which is used to quantify the components of sinusoidal, harmonic and non-harmonic signals.

### Spectrum

Description of a quantity as a function of frequency or wavelength

### Transducer

Device designed to convert energy from one form to another in such a manner that the desired characteristics of the input energy appear at the output

**Sampling rate**

Number of samples per unit of time, angle, revolutions or other mechanical, independent variable for uniformly sampled data

**Velocity**

Rate of change of displacement

In general, velocity is time-dependent.

The reference frame is usually a set of axes at a mean position or a position in rest. In general, a rotation velocity vector, a translation velocity vector, or both can represent the velocity.

**Vibration**

Mechanical oscillations about an equilibrium point. The oscillations may be periodic or random.

**Window function**

Pre-defined mathematical function that multiplies a data block and improves some characteristics of the frequency description

## 2 Measurements

### 2.1 Measurements procedure

The measurement procedure is as follows:

- Preferably use acceleration transducers and detect overall vibration velocity levels in mm/s RMS.
- If frequencies below 10 Hz are expected/observed, it is recommended to measure the overall vibration displacement in mm/s RMS (it is common practice to measure displacement in micrometers  $1 \mu\text{m} = 10^{-6}$  meters).
- If frequencies above 200 Hz are expected/observed, it is recommended to measure the overall RMS vibration acceleration in  $\text{m/s}^2$  RMS (it is common practice to measure acceleration in units of  $g$ :  $1g = 9.81 \text{ m/s}^2$ ).
- All levels must be within the guide levels for acceptable overall vibrations as summarised in chapter 4.3.

NOTE: Acceleration levels are normally being applied for condition monitoring of internal parts of the compressor. However, the EFRC Guideline is not intended to apply for condition monitoring purposes. If the condition of e.g. the valves should be monitored, one should follow another procedure with different levels. The accelerations levels from this guideline should therefore only serve as a screening criterion to judge the integrity of equipment which is attached to the compressor; e.g. pressure/temperature transmitters, valve lifting devices etc. When the acceleration levels in this guideline are exceeded this does not by definition imply that corrective actions are required. The susceptibility of components to high accelerations levels (instruments, heavy components on small equipment nozzles, etc.), the presence of audible noise/knocking sounds or unusual/sudden changes then should become a point of attention and further analysis.

Further on it should be kept in mind that the measured acceleration levels are not the levels of the attached equipment but the levels of the compressor system parts (foundation, crankcase, cylinder, dampers and piping) to which they are mounted.

#### 2.1.1 Measuring instrument and measured quantities

Criteria for classifying vibration levels for reciprocating compressor systems are specified in chapter 4. It is recognized that the main excitation frequencies for reciprocating compressors are generally found in the range 2 Hz to 300 Hz. However, when considering the complete compressor, including auxiliary equipment that is a functional part of the compressor, a typical range between 2 Hz to 1000 Hz is applied to characterize the overall vibration level. For special purposes, a different range may be agreed between the manufacturer and customer.

Since the overall vibration signal usually contains many frequency components, there is no simple mathematical relationship between the RMS and peak, or peak-to-peak overall vibration measurements. Therefore the preferred measuring system should provide the overall RMS values of displacement, velocity and acceleration with an accuracy of  $\pm 10\%$  over the range 10 Hz to 1000 Hz and an accuracy of  $+10\%$  and  $-20\%$  over the range 2 Hz to 10 Hz. ISO 2954 gives more guidelines on calibration. These values may be obtained from a single sensor whose signal is processed to derive the quantities not directly measured; preferably an accelerometer whose output is integrated once for velocity and twice for displacement. Care should be taken to ensure that any processing does not adversely affect the required accuracy of the measuring system. Both the frequency response and measured vibration levels are affected by the method of attachment of the transducers, see Appendix B.



It is especially important to maintain a good attachment between the transducer and the compressor when the vibration velocities and frequencies are high. For example, ISO 5348 gives guidance on the mounting of accelerometers.

## **2.2 Points and direction of measurements**

The vibration measurements must be carried out minimum on the locations as shown in figure 3.1 and figure 3.2.

- Foundation: at all compressor foundation bolt locations;
- Compressor frame: on each corner point and on each connection of the crosshead guide for a compressor with more than 2 cylinders, all at the top of the frame;
- Compressor cylinder: at the rigid part of each cylinder cover flange;
- Suction and discharge pulsation dampers: at the inlet/outlet flange and at the heads (for vertical dampers only the head on the top);
- Piping: at all critical parts in the system including small bore piping, to be determined in agreement with operator.

The measurements must be taken in 3 perpendicular directions.

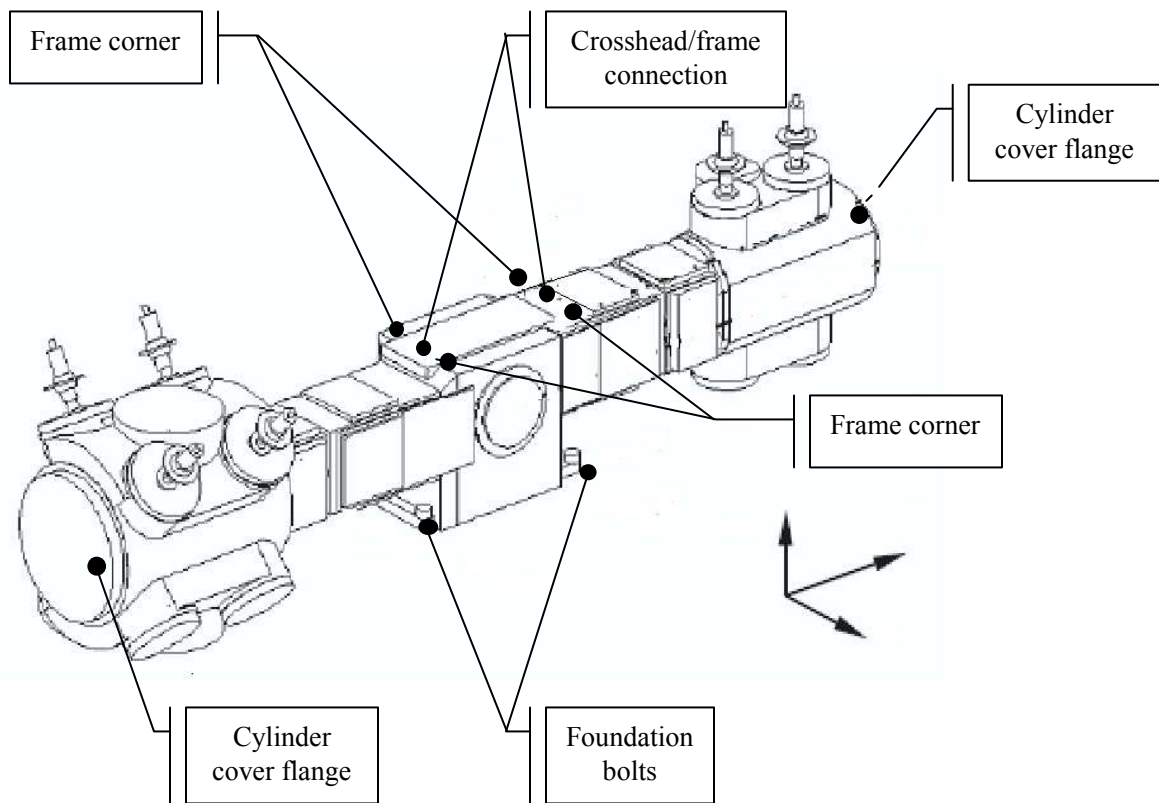

Figure 3.1 Measuring locations on the compressor for horizontal compressors

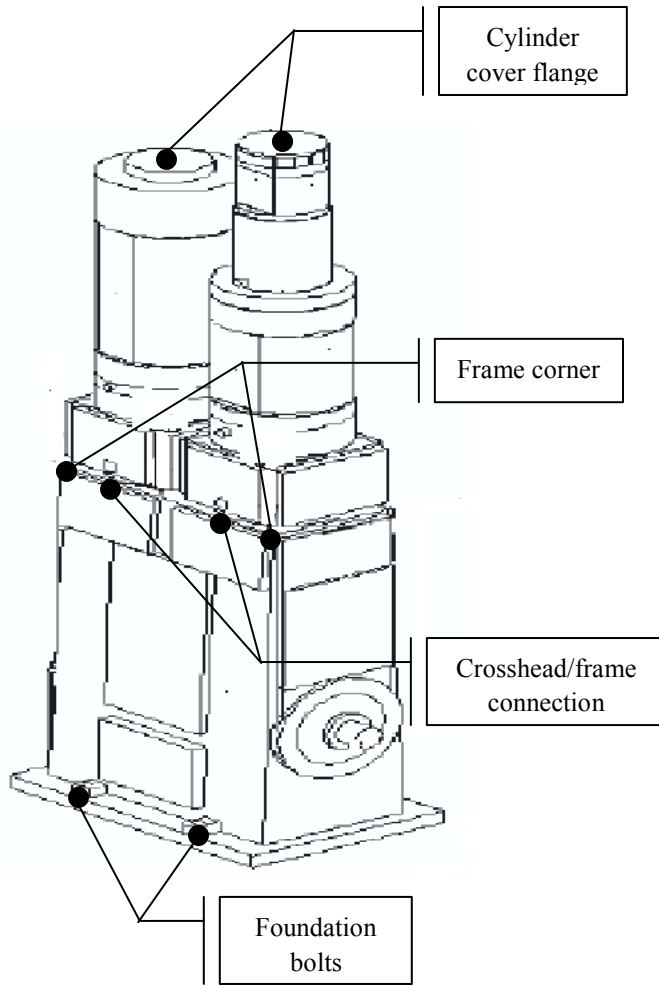

Figure 3.2 Measuring locations vertical compressors

### 2.3 Operating conditions

Measurements should be taken when the compressor has reached its steady-state operating conditions (e.g. normal operating temperature). The determination of the compressor vibration levels shall be based on the maximum vibration levels occurring over the entire speed range (if applicable), for all operating conditions (e.g. different pressures), specified alternative gases (e.g. N<sub>2</sub> for start-up), unloading conditions, single and multiple compressors in service, etc.

### 2.4 Record of measured results

Records of all measured results should include essential data of the compressor systems and of the measuring systems used.

### 3 Vibration Criteria

#### 3.1 Measuring quantities

The limits for overall vibration displacements, vibration velocities and vibration accelerations are in RMS.

#### 3.2 Key zones

The following typical evaluation zones are defined in the same way as defined in ISO 10816 to permit a qualitative assessment of the vibration on a given compressor and to provide guidelines on possible actions. Numerical values assigned to the zone boundaries are primarily intended to serve as guide values and are not intended to serve as a final acceptance criterion. The guide values for acceptable vibrations are intended to ensure that gross deficiencies or unrealistic requirements are avoided.

In certain cases, there may be specific features associated with a particular compressor system which would require different boundary values (lower or higher) to be used. In such cases, it is normally necessary to explain the reasons for this and, in particular, to confirm that the compressor system will not be endangered by operating with higher vibration levels.

Interim values for the zone boundaries for reciprocating compressor systems are defined as follows and have been summarised in table 4.1:

- A: The vibration of newly commissioned compressors would normally fall within this zone.
- B: Compressors with vibration within this zone are normally considered acceptable for long-term operation.
- C: Compressors with vibration within this zone are normally considered unsatisfactory for long-term continuous operation. Generally, the compressor may be operated for a limited period in this condition until a suitable opportunity arises for remedial action.
- D: Vibration values within this zone are normally considered to be of sufficient severity to cause damage to the compressor.

Table 4.1 Definition of key zones:

Zone	Level	Description	Notes
A	< A/B boundary	Good	Test-bed, as-designed, on-installation
B	>A/B – B/C	Acceptable	Acceptable for in-field operation
C	>B/C – C/D	Marginal	Analysis and possible correction. Clarify between OEM and operator that the compressor is suitable for long term safe operation
D	>C/D boundary	Unacceptable	Urgent correction or shutdown

#### 3.3 Guide values for acceptable overall vibrations (displacement, velocity and acceleration)

The guide values for acceptable vibration displacement, vibration velocities and vibration accelerations levels for a horizontal and vertical compressor system are summarised in table 4.2 through 4.4 and in figure 4.1 through figure 4.6

Table 4.2- Summary of vibration displacement levels for different parts and key zones

Part	Horizontal compressors [mm RMS]			Vertical compressors [mm RMS]		
	Key zones			Key zones		
	A/B	B/C	C/D	A/B	B/C	C/D
Foundation	0.032	0.048	0.072	0.032	0.048	0.072
Frame (top)	0.085	0.127	0.191	0.085	0.127	0.191
Cylinder (lateral)	0.139	0.207	0.310	0.170	0.255	0.382
Cylinder (rod)	0.170	0.255	0.382	0.139	0.207	0.310
Dampers	0.202	0.302	0.454	0.202	0.302	0.454
Piping	0.202	0.302	0.454	0.202	0.302	0.454

Table 4.3- Summary of vibration velocity levels for different parts and key zones

Part	Horizontal compressors [mm/s RMS]			Vertical compressors [mm/s RMS]		
	Key zones			Key zones		
	A/B	B/C	C/D	A/B	B/C	C/D
Foundation	2.00	3.00	4.5	2.00	3.00	4.50
Frame (top)	5.33	8.00	12.0	5.33	8.00	12.0
Cylinder (lateral)	8.67	13.0	19.5	10.67	16.0	24.0
Cylinder (rod)	10.67	16.0	24.0	8.67	13.0	19.5
Dampers	12.67	19.0	28.5	12.67	19.0	28.5
Piping	12.67	19.0	28.5	12.67	19.0	28.5

Table 4.4: Summary of vibration accelerations levels for different parts and key zones

Part	Horizontal compressors [m/s <sup>2</sup> RMS]			Vertical compressors [m/s <sup>2</sup> RMS]		
	Key zones			Key zones		
	A/B	B/C	C/D	A/B	B/C	C/D
Foundation	2.51	3.78	5.65	2.51	3.78	5.65
Frame (top)	6.70	10.05	15.08	6.70	10.05	15.08
Cylinder (lateral)	10.89	16.34	24.50	13.40	20.11	30.16
Cylinder (rod)	13.40	20.11	30.16	10.89	16.34	24.50
Dampers	15.92	23.88	35.81	15.92	23.88	35.81
Piping	15.92	23.88	35.81	15.92	23.88	35.81

**NOTE on Foundation.**

The vibration levels as indicated in the tables are valid for rigid mounted compressor systems. This means that the compressor must be mounted directly to the concrete foundation. If the compressor is mounted on a skid, the skid must be stiff enough and directly mounted to the concrete foundation. Isolated mounted foundations e.g. concrete block on springs and skids on anti-vibration mounts (AVM's) are an exception and the vibration levels for such systems should be agreed upon with the customer.

**NOTE on Compressor Cylinders**

The gas (stretching) force in the cylinder is causing a vibration in the rod direction. In general the vibrations in the rod direction are higher than in the lateral direction. The vibrations in rod direction of

the cylinder cause tensile and compressing stresses and is generally considered less harmful than the lateral vibrations which cause bending stresses. For that reason, higher vibration levels in the rod direction of the cylinder are allowed than in the lateral direction.

For vertical compressors, higher vibration levels in lateral direction than in the rod direction of the cylinder are allowed due to the fact that the vertical compressor is in general more flexible in the lateral direction than a horizontal compressor.

**NOTE on Damper and Piping**

Fatigue failures occur frequently on small bore and instrument connections (e.g. purge lines, measuring lines, closed side branches with a heavy valve or heavy valves and/or flange mass, connected to pulsation dampers (e.g. double block and bleed valves) and main piping. Special attention shall be paid to these small bore lines during vibration measurements, see API Standard 618 for guidelines on mechanical restraints e.g. how to brace these lines.

**NOTE on applied material**

It should be noted that several materials are more susceptible to crack initiation, e.g. cast iron and several high alloy materials are more brittle than carbon steel.

When more information is available, guidance may be provided on this subject to adjust the guide values as given in this chapter.

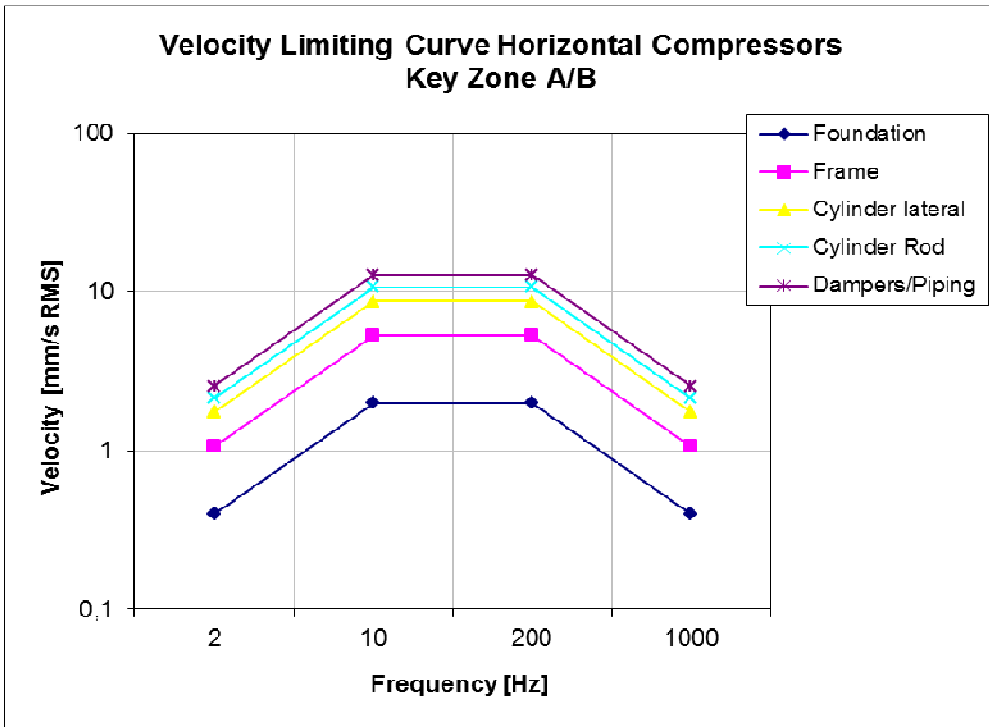

Figure 4.1. Vibration velocity limiting curve in for a horizontal compressor for key zone A/B.

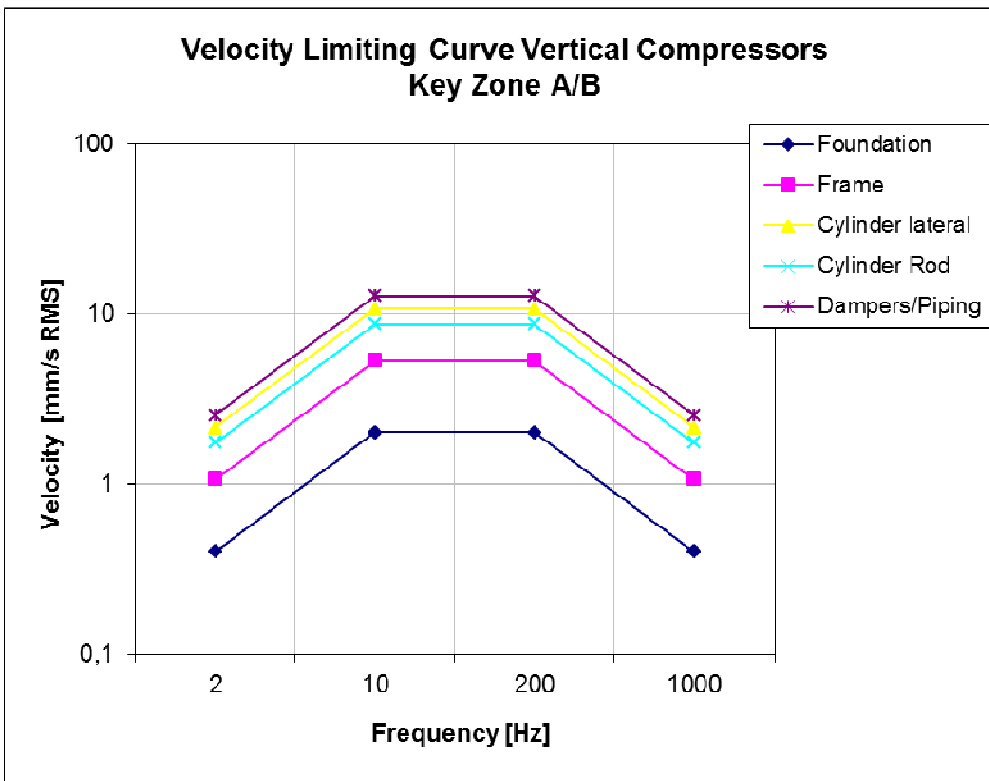

Figure 4.2. Vibration velocity limiting curve for a vertical compressor for key zone A/B.

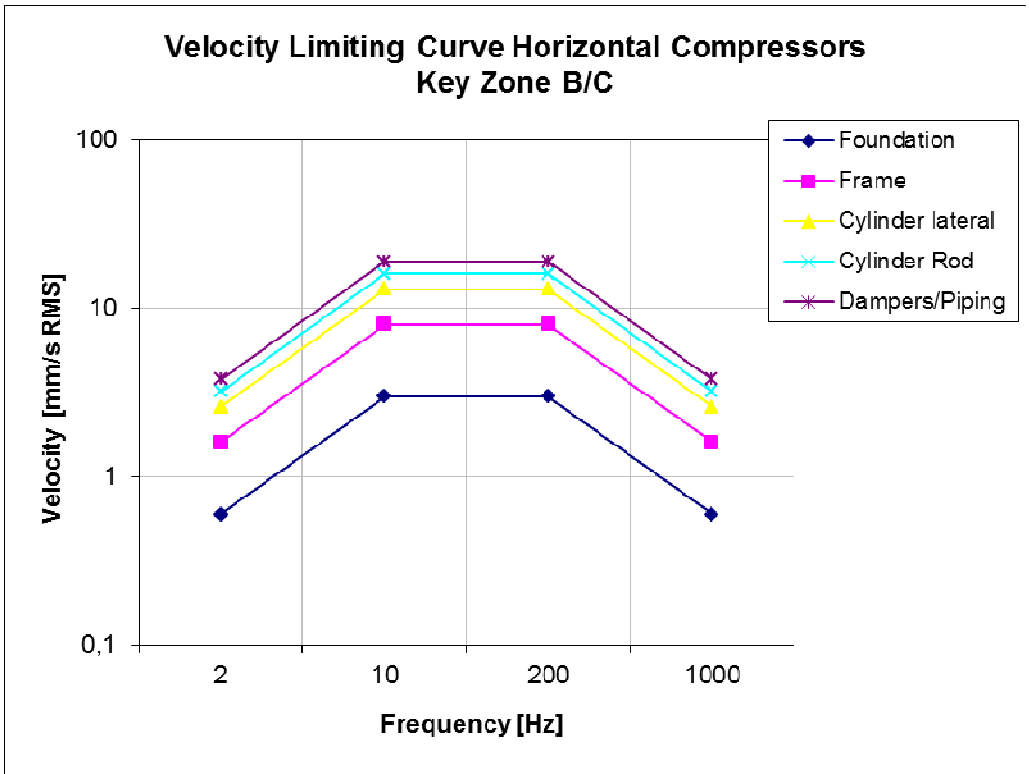

Figure 4.3- Vibration velocity limiting curve for a horizontal compressor for key zone B/C.

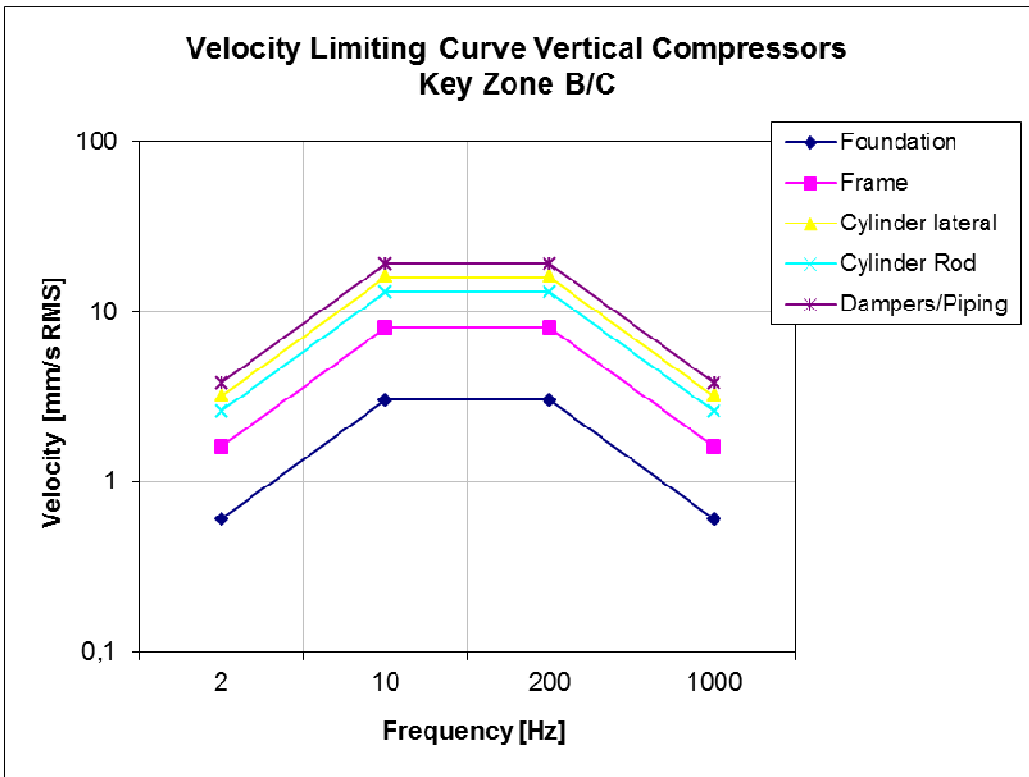

Figure 4.4- Vibration velocity limiting curve for a vertical compressor for key zone B/C.



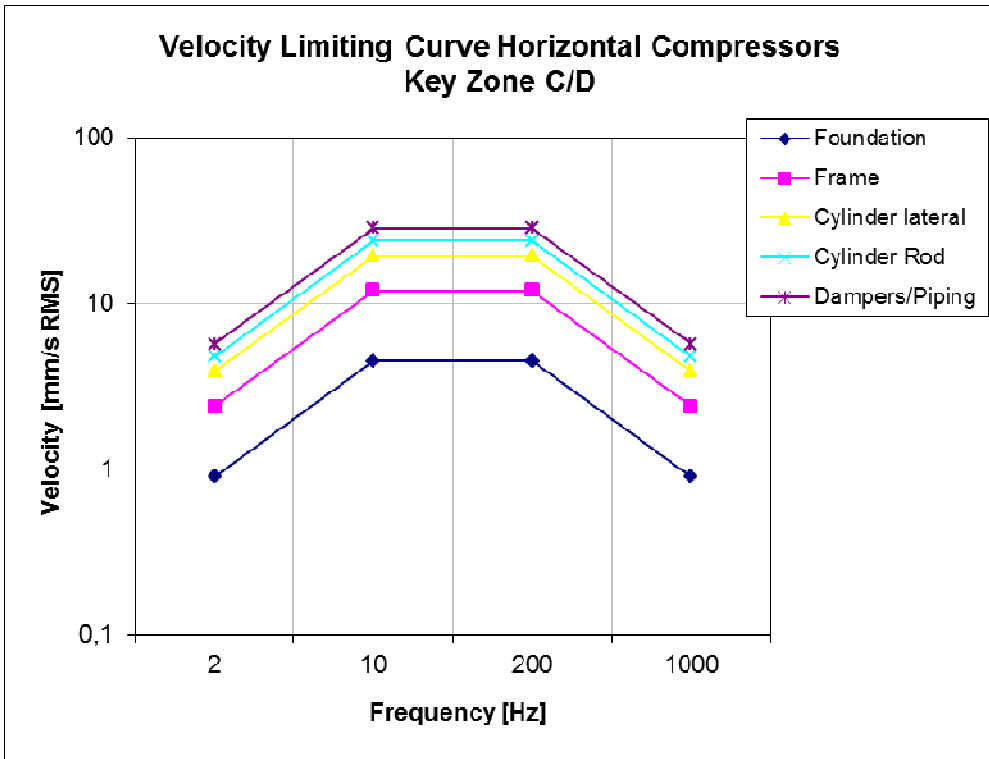

Figure 4.5.-Vibration velocity limiting curve for a horizontal compressor for key zone C/D.

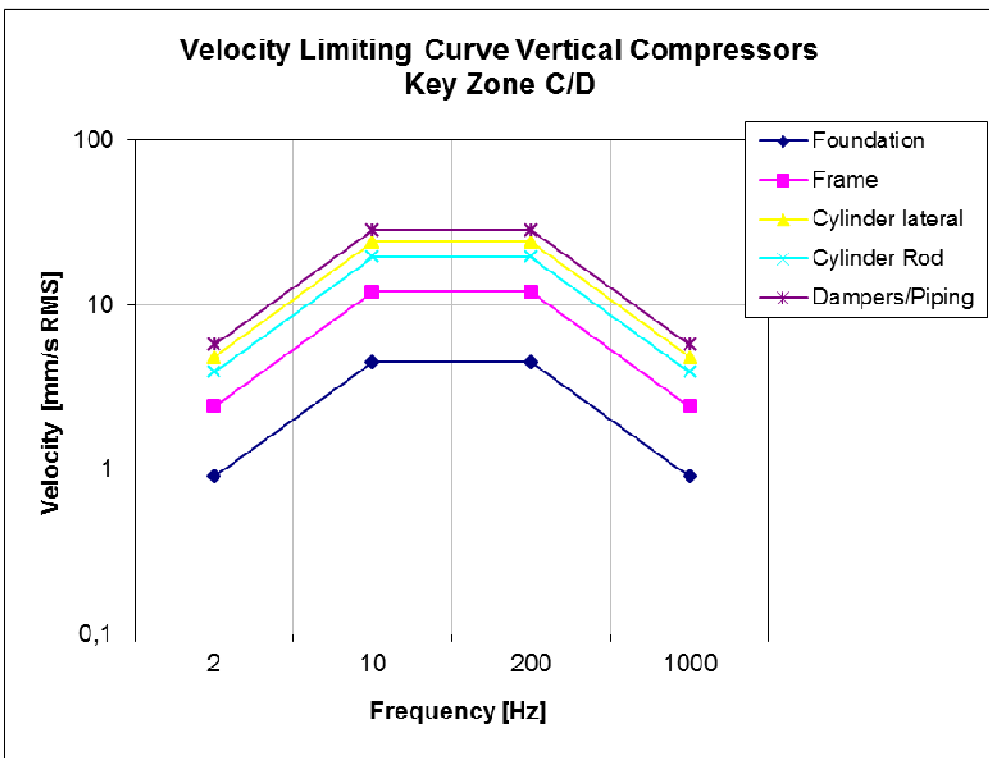

Figure 4.6.-Vibration velocity limiting curve for a vertical compressor for key zone C/D.

# Annex A: Measuring procedure and data processing

## A 1. Compressor details:

As a minimum for each compressor being measured, the following information should be recorded:

### EXAMPLE

Unique compressor identifier	equipment code or tag number
Rated speed:	rpm or Hz
Speed variation (if applicable):	minimum speed, maximum speed: rpm or Hz
Rated power:	kW
Configuration:	horizontal/vertical
Compressor support:	rigid or resiliently mounted
Shaft coupling:	rigid or flexible
Type of flow control:	valve unloaders, bypass, clearance pocket, step less flow reversal control, speed,

The following information may also be useful to record:

Type of driver:	electric/steam/gas/reciprocating/diesel/hydraulic
-----------------	---

## A 2. Measurements

For each measuring system, the following information should be recorded:

### EXAMPLE

Date, and time (including time zone)	
Instrument type:	
Measurement location, orientation:	drawing (preferred), description or code
Measurement units:	mm/s, m/s <sup>2</sup> or g's, mm or μm
Measurement units qualifier:	peak, peak-peak, RMS
Measurement type:	overall/amplitude over time/spectrum/etc
Transducer type:	eddy current/velocity/accelerometer etc
Transducer method of attachment:	probe/magnet/stud/adhesive etc
FFT or other Processing:	filter (e.g. low and high cut-off frequencies), number of lines, number of averages, number of samples
Calibration requirement:	type and date of last or next required calibration

### Process and operating parameters:

Speed during measurement:	rpm or Hz
Power during measurement:	kW
Operation of multiple compressors:	single, parallel
Load condition:	e.g. 100%, 75%, 50%, 25%, etc...
Other significant operating parameters:	temperatures, pressures, mol weight

## Annex B: Accelerometers

### B 1 General

The accelerometer is a contact sensor (as opposed to a non-contacting proximity probe) that measures the motion of the surface to which it is attached. Its many benefits include linearity over a wide frequency and dynamic range. Accelerometers are available with various mounted resonant frequencies, typically from 1 kHz upwards.

In general it is recommended that the linear range of the mounted accelerometer covers the frequencies of interest. It is common to integrate the output of an accelerometer to provide a velocity signal. However, caution shall be exercised when double-integrating to provide displacement, especially at low frequencies. If accelerometers are used with slow running compressors, suitable types will have a high transmission factor to ensure an adequate signal-to-noise ratio despite the double integration which is required for vibration displacement measurements. If the used accelerometer is not suitable to measure low frequencies, electro dynamic vibration velocity transducers should be applied in that case.

In order to apply the accelerometer and get reliable measurements, proper attention must be paid to the following areas:

- Sensor mounting configurations
- Frequency range of interest
- Amplitude of interest
- Characteristic of the particular accelerometer under considerations
- Cabling and signal condition
- Environmental considerations

### B 2 Mounting

Since the accelerometer is a contact device, care in mounting is of particular importance because improper installation can affect the performance of the device and give unreliable and unexpected output signals. Proper measurement of compressor vibration is critically dependent on accurately transmitting the motion to the transducer. The broadest range of fidelity is obtained with fixed transducer attachments. However, in many cases, hand-held or magnet-attached probes are sufficient. For a complete description of transducer attachment methods of accelerometers and their effect on performance, refer to ISO 5348. General guidelines are included below.

The preferred method for attaching fixed transducers is a rigid mechanical fastening which is commonly achieved by drilled and tapped holes in the transducer and the compressor, and joining the two by a threaded stud. Stud mounting has the ability to transfer high-frequency signals with little or no signal loss.

The contact surface should be smooth, flat and clean. However, this method of mounting is rather time consuming and not always allowed or practically feasible. In most cases it is not required because the frequency range of interest is limited up to typically 1000 Hz for vibration measurements for reciprocating compressor systems. For that reason a common applied technique for non-intrusive transducer fastening is with a permanent magnet.

However, it should be noted that the flatness of the mounting surfaces is critical in this technique. For pipe systems it is advised to mount the transducer on the flat areas of flanges, or to utilise magnets with two parallel feet which allow attachment to surfaces with single-axis of curvature.

In case of non-magnetic materials (often applied for piping and pulsation dampers), cements or glues can be used to fasten the transducer to the surface. The cement or glue used shall be of the type that

has high stiffness characteristics when cured. Resilient adhesives should be avoided as they reduce the fidelity of the transmission of the signal.

Another method is the application of hand-held probes. Hand-held probes are frequency-limited and are normally not recommended for use above 1 kHz. Both accuracy and repeatability are likely to be compromised by the use of hand-held probes. Moreover, some structural motions at the higher frequencies can invalidate hand-held probe measurements, even though such motions may not be detectable with the probe. In order to demonstrate the effect on transducer performance of the various transducer attachment methods described above, the mounted resonant frequency of an accelerometer, with an internal 30 kHz resonant frequency, is typically reduced as shown in Table B.1.

Table B.1 Effect of accelerometer mounting method on resonant frequency

Effect See Fig B.2	Mounting method	Effect on system resonant frequency ( $f_r$ )	Comment Assuming an accelerometer with 30 kHz resonant frequency
1	Rigid stud mount	No effect	e.g. M6 stud with flat machined location point
2	Isolating stud mount	Reduced to about 28 kHz	e.g. mica washer
3	Stiff cement mount	Reduced to about 28 kHz	e.g. iso-cyanate adhesive (superglue™ or crazy glue)
4	Quick-fit stud mount	Reduced to 10 – 20 kHz	Will depend on cleanliness
5	Soft epoxy mount	Reduced to about 8 kHz	e.g. two part epoxy filled resin
6	Permanent magnet mount	Reduced to 2 – 7 kHz	Will depend on magnet and attachment surface flatness/curvature
7	Hand-held probe (stinger)	Reduced to 0.5 – 2 kHz	Will depend on material and length of probe e.g. For probe length 228 mm (9") $f_r \approx 0.75$ kHz

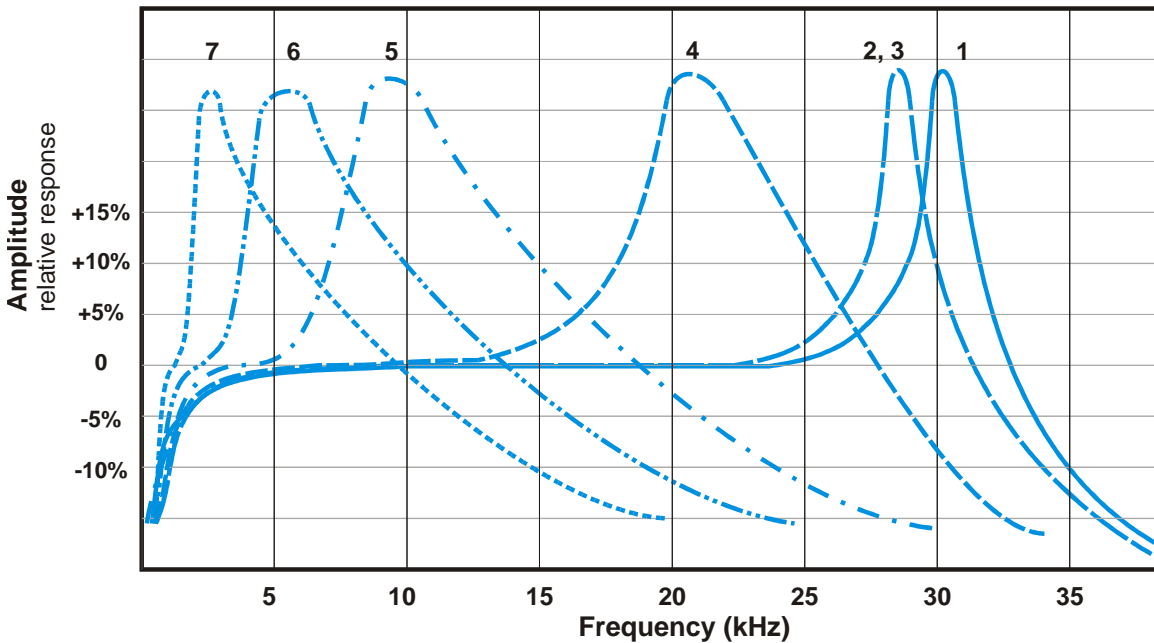

Figure B.2 Schematic of mounting effect on transducer response

Note: Reference numbers on graphs refer to Table B.1

### B 3. Cables

Stiff cables can cause case strain when used with accelerometers with axial connectors. Careful clamping of the cables is required to avoid such problems (see figure B1). Loose cables may introduce tribo-electric effects for piezo-electric type transducers with separate remote charge-coupled amplifiers. This is generally not a problem with IEPE (Integrated electronics piezo-electric) accelerometers.

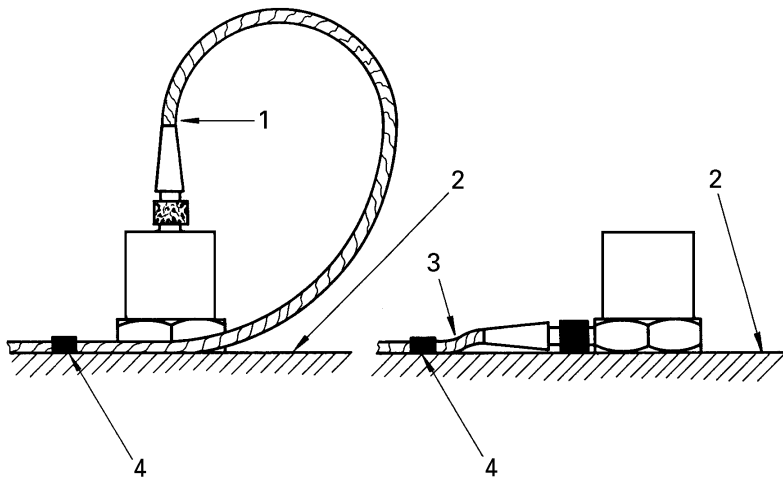

Figure B1. Correct mounting of cables

- a) left picture: accelerometer with axial connector
- b) right picture: accelerometer with radial connector

## Annex C: Post processing

### C 1. General

Unless prior knowledge dictates otherwise, the baseline broadband vibration should be acquired covering a sufficient dynamic range and frequency response to include all forcing excitations of interest within the compressor. Procedures for measuring broadband vibration can be found in the ISO 7919 and ISO 10816 series, respectively.

Broadband vibration does not always provide sufficient information to identify the specific cause of a problem. This is especially true for complex equipment where several excitation frequencies appear in the frequency spectrum. In such cases it is advisable to split the broadband vibration signal into discrete frequency components (amplitude and/or phase).

In most cases individual frequencies can be matched with corresponding compressor speeds or harmonics of the compressor speed and several types of problems (pulsation-induced or mechanical induced fatigue) can be detected by discrete frequency analysis. A sample frequency spectrum (FFT) plot is given in Figure C1. It clearly shows vibration amplitudes at specific frequencies.

It is important to evaluate the source of significant frequency peaks as their magnitudes can be abnormal and when immediately investigated can lead to early detection of a problem. Unexpected frequency components in the frequency analysis can also reveal some design configuration. More detailed procedures for converting a broadband time trace to a frequency spectrum is given in ISO 13373-2.

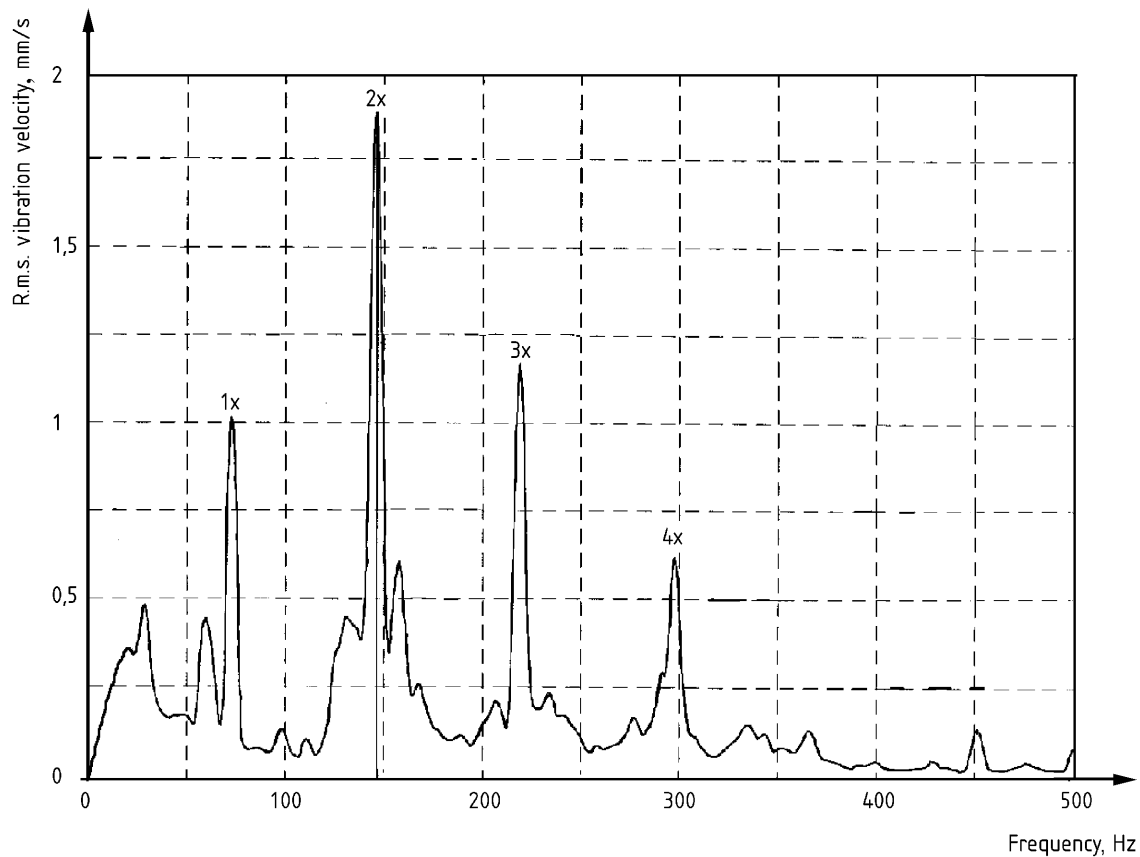

Figure C1. Typical frequency spectrum of a reciprocating compressor system

The following table shows some of the measurement parameter settings required to be selected before taking a vibration measurement.

Table C.1 – Typical vibration parameter acquisition options

Ref.	Description	Typical Choice	Examples
1	Transducer	Accelerometer	Accelerometer, velocity, displacement
2	Measurement Type		Acceleration, velocity, displacement
3	Data Format	Spectra	Time sample, spectra,
4	Trend Parameters		Overall RMS acceleration, Overall RMS velocity, Overall RMS displacement
5	Input Filter	2.5 Hz – 20 kHz	High pass (HPF), band pass (BPF), ISO 10816: 10-1000Hz
6	Other Trend	Crest Factor	Crest Factor, HFD
7	Other Processing	Envelope	
8	Sampling Rate	9600 Hz	4800 Hz, 9600 Hz, 19200 Hz (may be pre-set via option 10 & 11)
9	Sample Length	4096	2048, 4096, 8192 (may be pre-set via option 10 & 11)
10	FFT Lines	1600	100, 200, 400, 800, 1600, 3200, 6400, 12800 etc
11	Max. Frequency	2 kHz	500 Hz, 1 kHz, 2 kHz, 5 kHz, 10 kHz etc
12	FFT averages	4	0, 2, 4, 8, 16 etc (averaging reduces noise in FFT)
13	FFT Window	Hanning	None, Uniform, Hanning, Hamming, Exponential
14	FFT Anti Aliasing	Yes	Yes, No

## C 2. Digital signal processing (DSP)

### C.2.1 General

Modern digital Dynamic Signal Analysers (DSA) carry out sampling and processing of data quickly and cheaply. However they can apparently modify the input signal and introduce spurious components unless careful selection of features such as linear averaging, time synchronous averaging, exponential averaging, overlapping data, acquisition time, dynamic range influence, truncation, anti-aliasing and noise elimination. See ISO 13372-2 for details on these functions.

To illustrate some of these requirements, a schematic of some of the functions of a modern DSP are shown in Figure C.2

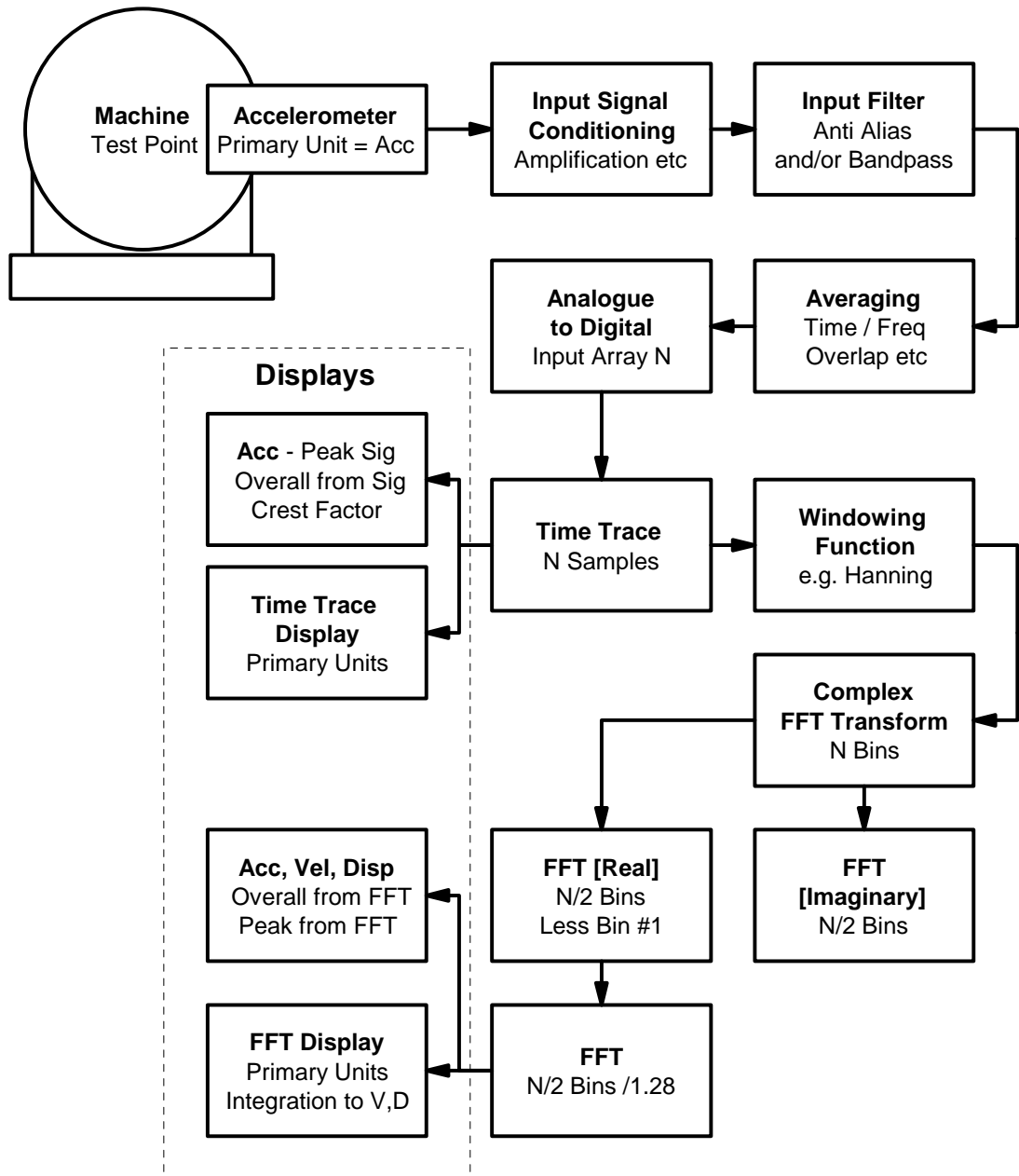

Figure C.2 – Schematic of Typical Digital Signal Processing

### C 2.1 Averaging

Averaging is a process to improve clarity of harmonic signals, and may be carried out in the time or frequency domain. ISO 13372-2 contains useful information regarding averaging. Averaging reduces the effect of non-synchronous components and noise.

Digitized signals can be averaged over configurable periods of time by means of various different methods. Averaging in the time range is a much faster way of removing noise and noise-like signal components than averaging spectra. However, time signals must be in-phase to be averaged.



A reference mark transmitter or a very distinct signal flange are suitable ways of ensuring this. The averaging process can be followed either live by displaying the instantaneous values (dynamic averaging) or the result is not displayed until all averaged values have been collected (static averaging). In the case of linear averaging the individual measurements are given equal weight; in other words, they exert the same influence on the mean value.

With exponential averaging this influence varies. The greatest weighting is given to the latest measurements. For this reason it is particularly suitable for following an unfolding process and observing the influence of different operational quantities.

Peak value averaging, on the other hand, saves the signal value which is numerically the greatest. It is useful for analyzing individual results such as shocks or passages of resonance.

## C 2.2 Filtering

A distinction is drawn in digital filters between recursive and non-recursive filters. Recursive digital filters are an imitation of the corresponding analogue filters. All the same, in this case slope is not a question, but instead the cut-offs for the pass and stop ranges are defined with reference to the sampling frequency.

Low-pass filters are used, for example, for excluding interference arising from the excitation of the weakly attenuated natural frequency of accelerometers (see figure C.3).

Furthermore the ripple in the pass range and the attenuation in the stop range must be defined. Non-recursive digital filters cannot be compared with analogue filters. Any frequency responses can be handled with this type of filter.

To avoid large errors when integrating measured accelerations into vibration and displacement, the low frequency cut-off should be set at a value about half the lowest frequency of interest, keeping in mind the frequency response of the applied accelerometer. The basic frequency of the compressor should always be included and for measurements on reciprocating compressor installations the filter should be adjusted to a typical value of 2-3 Hz.

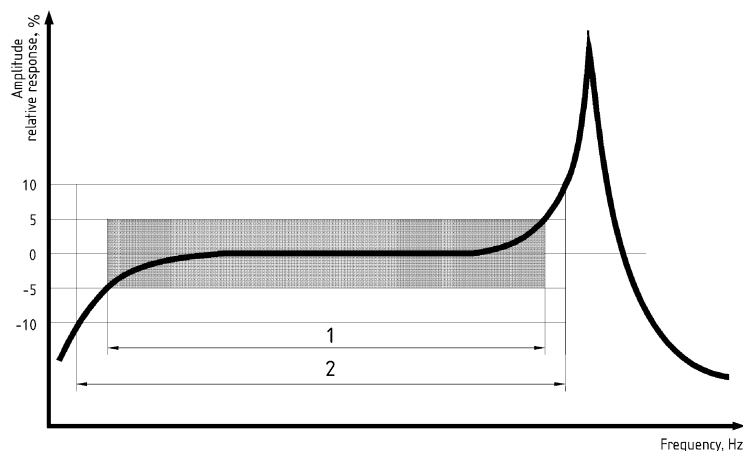

Figure C.3 Acceleration frequency response (type 1 linear range, type 2 non-linear range)

### C 2.3 Formation of the characteristic quantities

RMS-values (or peak) values can be obtained directly from the digitized signal mathematically. To prevent fluctuations in digital displays an averaging process can also be connected, as described in Section C 2.1.

### C 2.4 Signal display

How the measured and processed signals are displayed is extremely important in diagnostics. There is not just one way of displaying signals but a number of different ways which have varying degrees of suitability for the various vibration phenomena. They may have identical signal content but still reveal very different information about the physics behind what is happening. Figure C.4 shows one example of two different ways of displaying a signal – in the time range and in the frequency range. Our recommendations and what we have to say here about suitability should not be taken as unqualified restrictions. In many cases phenomena which are hard to distinguish in one form of display are a simple matter to interpret in another.

There are advantages in viewing peak and overall values derived from a time signal, rather than post FFT processing. Consideration of overall and peak, and crest factor (the ratio of peak to rms) can give important indications of the signal content without recourse to Spectra.

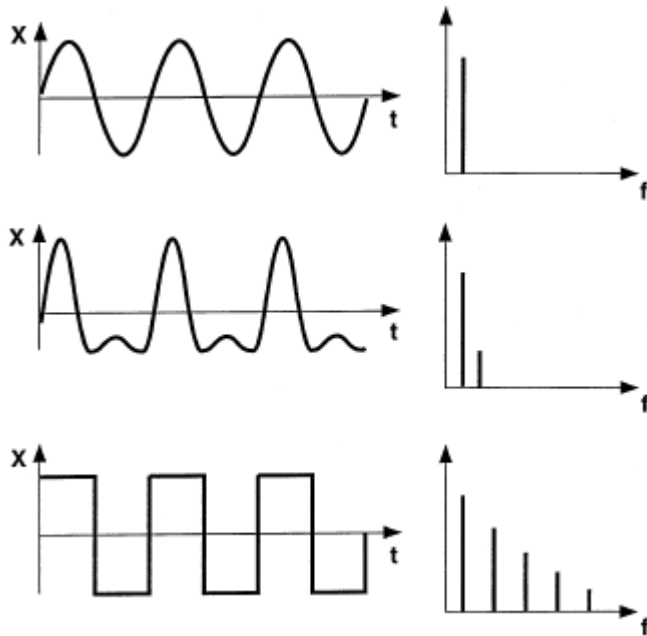

Figure C.4 Displaying measured values in the time range (left) and in the frequency range (right)

### C 2.5 Displaying in the time range

When a vibration signal is plotted as a curve against time this reveals whether one is dealing with stationary, periodic, or quasi-periodic beats e.g. parallel running compressors with a difference in speed, see also figure C.5.

This also simplifies monitoring for interference or intermittent connections. Such problems would not be easily detectable from plots of rms or peak values. If time curves are to be recorded using continuous line recorders these must be able to reproduce accurately oscillations with frequencies up

to multiples of the rotational frequency. Interpretation is made more difficult by averaging temporally diverse vibration patterns.

Recording the time curve of the rms or peak value of a vibration is recommended when the vibration characteristics change, for example, with compressor load, speed, warming up after starting, or when other equipment is switched on.

In most cases it will then be necessary to record additional operating parameters with the same recorder. Comparison of the time curves may provide information on the causes of such changes in the vibratory pattern.

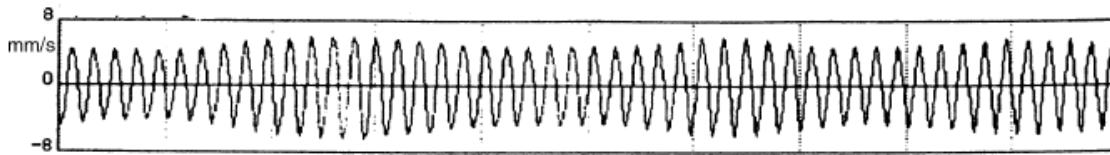

Figure C.5 Time curve for vibration with beating caused by two parallel running reciprocating compressors

## C 2.6 Displaying in the frequency range

### C 2.6.1 Frequency analysis, frequency diagram

Frequency analyses are a major aid in the interpretation of vibration measurement results. They provide information about the source of vibration excitation and often reveal components of the vibration signal which are important in diagnosis. As can be seen from figure C.6, when a signal is plotted as a time function these components are virtually indistinguishable while in a spectral analysis diagram, on the other hand, they are clearly apparent. In many cases specific frequency components can be assigned to individual exciters or compressor parts.

Irregularities or damage will result in changes in the spectrum. They can be detected at an early stage and frequently linked with particular causes. This includes problems such as unbalances of mechanical or thermal origin, self-excited vibration, brushing of compressor parts against each other, changes in alignment, defective bearings and gears, faulty mechanical connections, cracks in shafts and so on.

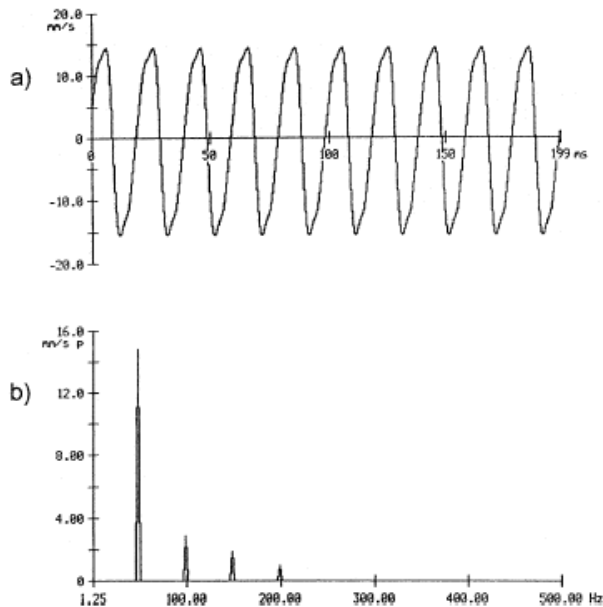

Figure C.6 Small components of the vibration signal are hard to detect in time-curve diagrams (a) but become clear in frequency analyses (b)

Narrow-band analyses can be carried out with various kinds of analogue measuring instrument. For this purpose they are fitted with a manually or automatically tuneable filter of a defined absolute bandwidth. The amplitudes of the individual frequency components can be displayed or also recorded. Frequency analyses of this type require a period of time during which the vibration signal must not change. The higher the desired frequency resolution, the longer the time period required.

If the measuring devices are equipped with a tracking filter which can be tuned to the rotational frequency or its harmonics, this will allow order analyses to be carried out as well.

Faster frequency analyses can be carried out with digital FFT analysers (fast Fourier transformation), especially when the analyzers are equipped with transient buffers for the short-term storage of a signal. FFT analysers display the spectra as a line diagram of limited resolution.

A common figure might be 400 lines for the selected frequency range. This yields a particular bandwidth for the individual line – for example, 0.25 Hz for the frequency range between 0 and 100 Hz at 400 lines. The consequence of the finite sampling time of the digital device in FFT analysis is the following effect. If the frequency of the input signal does not coincide precisely with a line, this blurs the spectrum – in other words, all adjacent lines will also be less markedly activated.

The only way to exclude this effect is to precondition the signal mathematically by means of a so-called window function. Here it is essentially only the lines directly adjacent which are still present. However the more these window functions prevent the blurring effect the more they tend to dampen the amplitude of the spectral components.

For this reason, with FFT analysers it should be possible to activate at least one window function which would minimize amplitude distortion (flat top, for example) and also another which would ensure optimum frequency (Hanning, Hamming, for example). The two demands are mutually exclusive. It should also be noted that most windows strongly attenuate the signal components at the beginning and end of measurement. One-off occurrences such as shock responses should therefore be processed without windowing but this is normally not required for reciprocating compressor systems.

In general, representation of a spectrum is restricted to plotting the individual amplitudes against frequency. In most cases this provides enough information for an analysis. But it is not until an additional phase spectrum is plotted (the phases of the individual spectral components plotted against frequency) that the signal information is accessible in its entirety. Most modern FFT analyzers display the two variables simultaneously. The amplitudes of the individual spectral components can be shown linearly or logarithmically.

Linear display of amplitude has a limited dynamic range. For this reason only the larger components in the spectrum are visible. In the case of logarithmic display, a dynamic range of 60 to 80 dB is possible. Compared with linear display, much more detail is evident. Which form of diagram is best, will therefore depend on the particular task to be performed.

Logarithmic display is more suitable for the early identification of problems (crack detection, for example) while linear display is better suited to revealing the origins of dominant frequency components.

The frequency scale, too, can be linear or logarithmic. A linear frequency scale is suitable for a constant filter bandwidth – in other words, the same resolution covers the entire frequency range, such as provided by an FFT/DFT (FFT: Fast Fourier Transformation; DFT: Digital Fourier Transformation) analysis, for example. Harmonics and side bands appear as equidistant lines and are thus easily recognizable. Using a logarithmic frequency scale means that a very large frequency range in a single spectrum can be presented (3 to 4 decades). However, one disadvantage is that with a constant absolute bandwidth the graphical resolution becomes poorer in the high frequency region. Harmonics and side bands are scarcely recognizable. Table C.2 shows combinations of different possible input, signal and digital processing options:

Table C.2 – Typical signal processing options

Ref.	Input	Raw Signal		Processed e.g. FFT / DFT		
		Time Trace	r.m.s	Spectra	r.m.s	Crest factor
1	accelerometer	acceleration	m/s <sup>2</sup> , g	acceleration	m/s <sup>2</sup> , g	Yes
2	accelerometer	acceleration	m/s <sup>2</sup> , g	velocity <sup>†</sup>	mm/s	-
3	accelerometer	acceleration	m/s <sup>2</sup> , g	displacement <sup>†</sup>	mm, micron	-
4	velocity	velocity	mm/s	acceleration <sup>‡</sup>	m/s <sup>2</sup> , g	-
5	velocity	velocity	mm/s	velocity	mm/s	Yes
6	velocity	velocity	mm/s	displacement <sup>†</sup>	mm, micron	-
7	displacement	displacement	mm, micron	acceleration <sup>‡</sup>	m/s <sup>2</sup> , g	-
8	displacement	displacement	mm, micron	velocity <sup>†</sup>	mm/s	-
9	displacement	displacement	mm, micron	displacement	mm, micron	Yes

Key:

† = integrated,

‡ = differentiated,

## References

1. ISO 10816-1: Mechanical vibration-Evaluation of machine vibration by measurements on non-rotating parts- Part 1: general guidelines. First edition 1995-12-15.
2. ISO 10816-6: Mechanical vibration-Evaluation of machine vibration by measurements on non-rotating parts- Part 6: Reciprocating machines with power ratings above 100 kW. First edition 1995-12-15.
3. ISO 2041: 2009, IDT: Mechanical vibration, shock and condition monitoring – Vocabulary,
4. ISO 2372-1974: Mechanical vibrations of machines with operating speeds from 10 to 200 rev/s-basis for specifying evaluation standards
5. ISO 2631-1: Mechanical vibration and shock- Evaluation of human exposure to whole-body vibration- Part 1: general requirements. Second edition 1997-05-01.
6. ISO 5348: Mechanical vibration and shock-Mechanical mounting of accelerometers. Second edition 1998-05-15
7. ISO 8528-9: Reciprocating internal combustion engine driven alternating current generating sets- part 9: measurement and evaluation of mechanical vibrations. First edition 1995-12-15
8. VDI 2056: Beurteilungsmaßstäbe für mechanische Schwingungen von Maschinen. Oktober 1964
9. VDI 2063: Measurement and evaluation of mechanical vibrations of reciprocating piston engines and piston compressors. September 1985
10. VDI 3838: Measurement and evaluation of mechanical vibrations of reciprocating piston engines and piston compressors with power ratings above 100 kW. Addition to DIN ISO 10816-6. May 2004
11. VDI 3839: Instructions on measuring and interpreting the vibrations of machines. Part 1- General principles. March 2001.
12. VDI 3839: Instructions on measuring and interpreting the vibrations of machines. Part 8- Typical vibration patterns with reciprocating compressors. June 2004.
13. VDI 3842: Vibrations in pipe systems. June 2004
14. DIN 4024: Compressor foundations. Part 1- Flexible structures that support compressors with rotating elements. April 1988
15. DIN 4024: Compressor foundations. Part 2- Rigid foundations for compressors subject to periodic vibration. April 1991
16. CEI-IEC 34-14: Rotating electrical compressors-Part 14: Mechanical vibration of certain compressors with shaft heights 56 mm and higher-Measurement, evaluation and limits for vibration. Second edition 1996-11
17. API Standard 618: Reciprocating compressors for petroleum, chemical and gas industry services, 4<sup>th</sup> edition June 1995.
18. ISO 13707: Petroleum and natural gas industries reciprocating compressors. First edition 2000-12-01
19. ISO 13373-1 Condition monitoring and diagnostics of machines-Vibration condition monitoring. Part1: General procedures
20. ISO 13373-2 Condition monitoring and diagnostics of machines-Vibration condition monitoring. Part2: Processing, analysis and presentation of vibration data
21. API Standard 670, 4<sup>th</sup> edition December 2000. Reaffirmed November 2003: “Compressor Protection Systems”,
22. DIN 45662: ”Schwingungsmesseinrichtungen”, 1996-2
23. ISO 2954:1975 Mechanical vibration of rotating and reciprocating machines - Requirements for instruments for measuring vibration severity